

REV.	SPECIFICATION	ECN NO.	APPD.
R4		ECN240516	

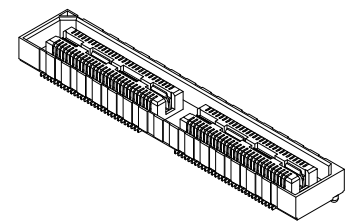
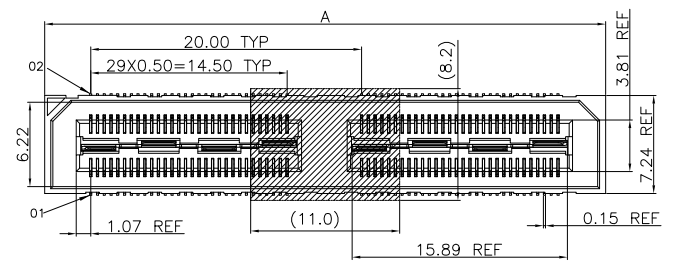

Material and Plating:
Housing: LCP, UL94V-0, Black.
Signal Contacts: Phosphor Bronze.
 Gold Plated on Contact Area and 80u" Min Tin Plated on Solder Tail over nickel 50u" Min .
Ground Contacts: Phosphor Bronze.
 Gold Plated on Contact Area and 80u" Min Tin Plated on Solder Tail over nickel 50u" Min .

Electrical Characteristics:
Current Rating: Signal: 3A Per Contact With 3 Adjacent Contacts (UL).
 Ground: 25A Per Contact With 1 Contact.

Voltage Rating: 125V AC .
Dielectric Withstanding Voltage: 525V AC For 1 minute.
Insulator Resistance: 5000MΩ min at DC 500V.
Contact Resistance: Signal: 45mΩ max .
 Ground: 15mΩ max .
Operating Temperature: -55°C ~ +125°C .
Durability: 250 Cycle .
***RoHS Compliant**

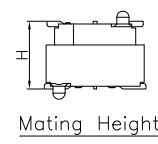
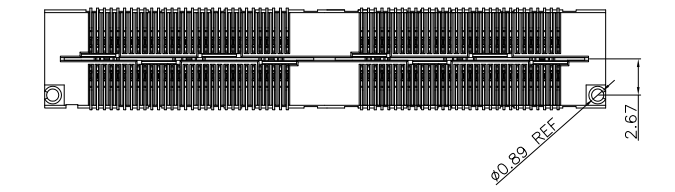
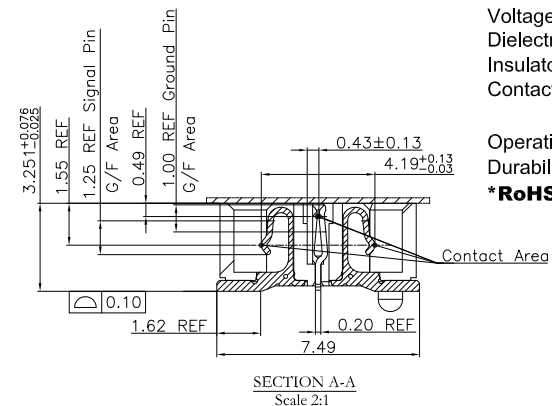
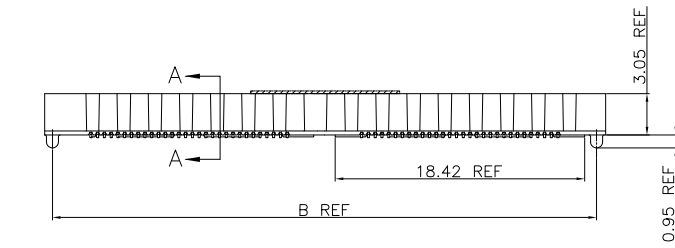

2384-A xx F C x D P 1 N x x x -x

Series: S: Mylar, Blank Without Pad
 Position: T: Tape & Reel Package, U: Tube Package, A: Tray Package
 F: Female
 C: Selective Gold Plated
 2: 05u", 3: 10u"
 D: SMD Type
 N: W/O Post, P: With Post, P1: Up & Down Post and P

Blank: Without Friction lock
 F: Friction lock
 Blank: Without Guides
 G: Guides Pin
 N: W/O Lock, L: With Lock(Press Fit), L1: With Lock(Solder)
 Code 1

Signaling (5mm Stack Height)	Speed Rating (No PCB Effect)
Single-Ended	9.5GHz/19Gbps
Differential	10.5GHz/21Gbps

Code:1~10 (A)	1	2	3	4	5	6	7	8	9	10
Male	4.267	7.267	10.267	15.243	18.240	21.237	24.237	29.238	13.269	14.270
Code:1	1	1	1	1	1	1	1	1	1	1
Female	3.25	3.25	3.25	3.25	3.25	3.25	3.25	3.25	3.25	3.25
Mating Height(H)	5.00	8.00	11.00	16.00	19.00	22.00	25.00	30.00	14.00	15.00

TABLE 2
 "*" Available Position

Code	Pos.	Dimension	
		A	B
1			
*	60	21.31	20.13
*	120	41.31	40.13

Tolerances	Dwg. No.	2384-D0000-011	Title:	2384-A Series High Speed Board to Board Pitch 0.5mm(Socket)
x = ±0.5	Projection			
.x = ±0.25	Unit	mm		
.xx = ±0.15	Scale	1:1		
	Drawn By	WP 05/11'24		

OUPIN
OUPIN ELECTRONIC(KUNSHAN) CO., LTD.
P/N: 2384-AxxFCxDP1Nxxx-x
 SHEET 1/6 Ver. No. R4

REV.	SPECIFICATION	ECN NO.	APPD.
R4		ECN240516	

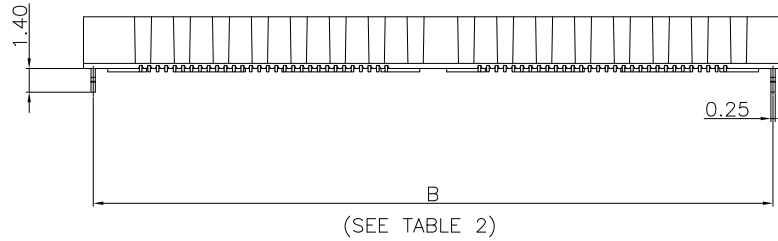
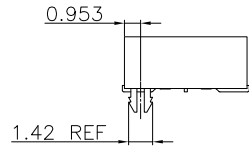

-L(With Lock)SAME AS SHEET 1 , EXCEPT AS SHOWN

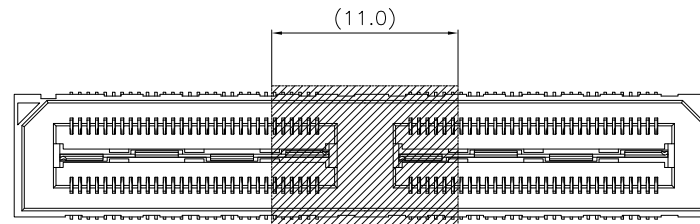
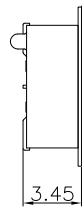

-S:Mylar

Tolerances	Dwg. No.	2384-D0000-011	Title:		 OUPIIN ELECTRONIC(KUNSHAN) CO., LTD.
x = ±0.5	Projection		2384-A Series		
.x = ±0.25	Unit	mm	Scale	1:1	P/N: 2384-AxxFCxDP1Nxxx-x
.xx = ±0.15	Drawn By	WP 05/11'24	High Speed Board to Board Pitch 0.5mm(Socket)		SHEET 2/6
					Ver. No. R4

REV.	SPECIFICATION	ECN NO.	APPD.
R4		ECN240516	

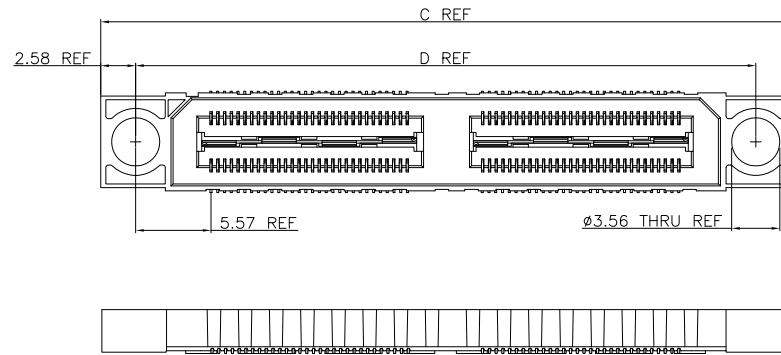

Pos.	Dimension	
	C	D
60	30.89	25.73
120	50.89	45.73

-G(Guides Pin) SAME AS SHEET 1, EXCEPT AS SHOWN

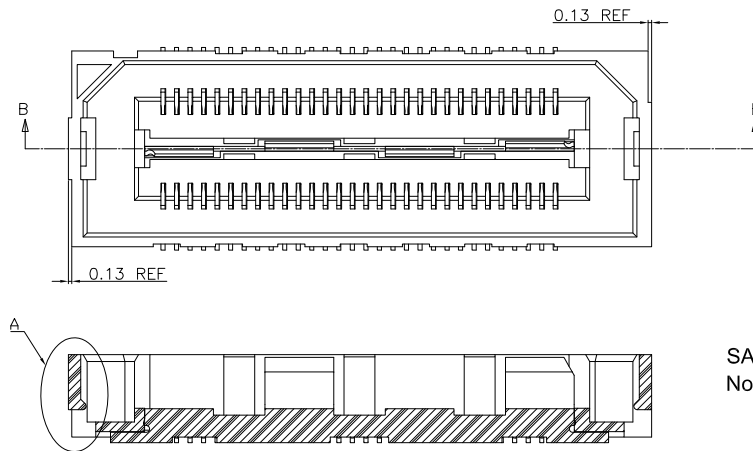

SECTION B-B
SCALE 4:1

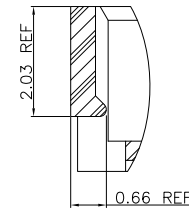

DETAIL A
SCALE 8:1

-F(Friction Lock)
SAME AS SHEET 1, EXCEPT AS SHOWN
Not Available with -G(Guides Pin) Options

Tolerances	Dwg. No.	2384-D0000-011		Title:	
x = ±0.5	Projection			2384-A Series	
.x = ±0.25	Unit	mm	Scale	1:1	High Speed Board to Board
.xx = ±0.15	Drawn By	WP 05/11'24			Pitch 0.5mm(Socket)

OUPIN			
OUPIN ELECTRONIC(KUNSHAN) CO., LTD.			
P/N:		2384-AxxFCxDP1Nxxx-x	
SHEET	3/6	Ver. No.	R4

REV.	SPECIFICATION	ECN NO.	APPD.
R4		ECN240516	

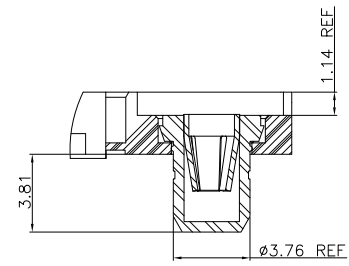
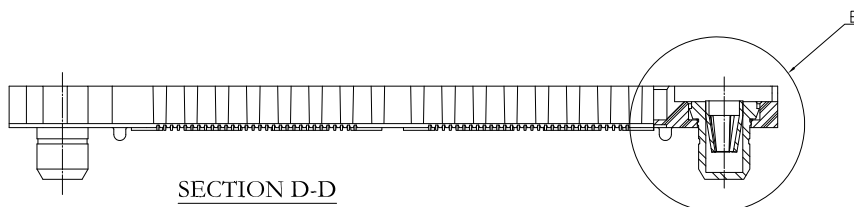
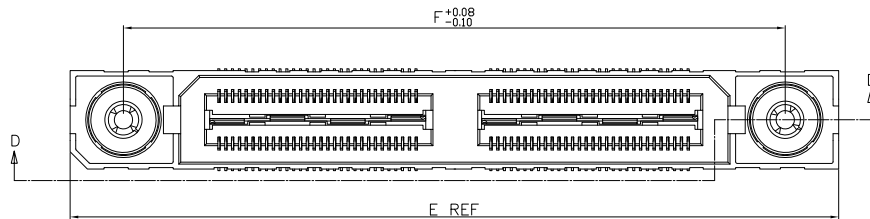

POS	E	F
60	36.51	28.66
120	56.52	48.67

-P1(Up & Down Post and P) SAME AS SHEET 1, EXCEPT AS SHOWN
(FOR -P STYLE ONLY)
(Not Available with -L,-G,or -F Options)

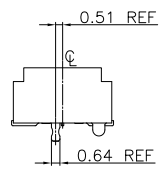
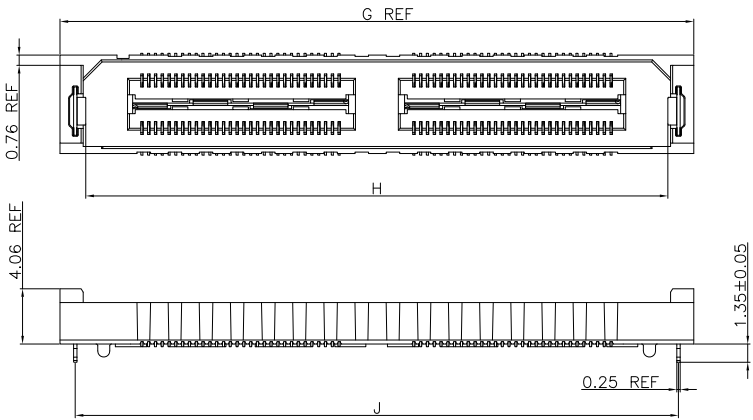

POS	G	H	J
60	26.61	22.78	24.36
120	46.61	42.78	44.36

-L1(With Lock) SAME AS SHEET 1, EXCEPT AS SHOWN
(Not Available with -L,-G,-F,or -P1 Options)

Tolerances	Dwg. No.	2384-D0000-011
x = ±0.5	Projection	
.x = ±0.25	Unit	mm
.xx = ±0.15	Scale	1:1
	Drawn By	WP 05/11'24

Title:
2384-A Series
High Speed Board to Board
Pitch 0.5mm(Socket)

OUPIN
OUPIN ELECTRONIC(KUNSHAN) CO., LTD.
P/N: 2384-AxxFCxDP1Nxxx-x
SHEET 4/6 Ver. No. R4

REV.	SPECIFICATION	ECN NO.	APPD.
R4		ECN240516	

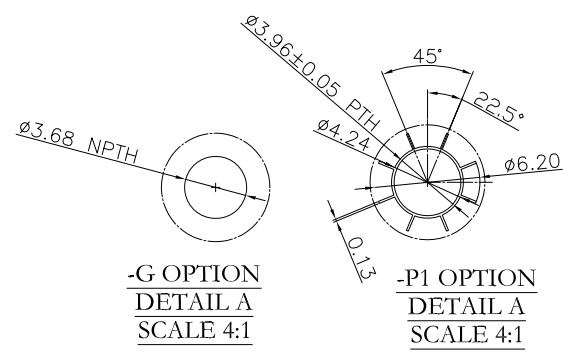
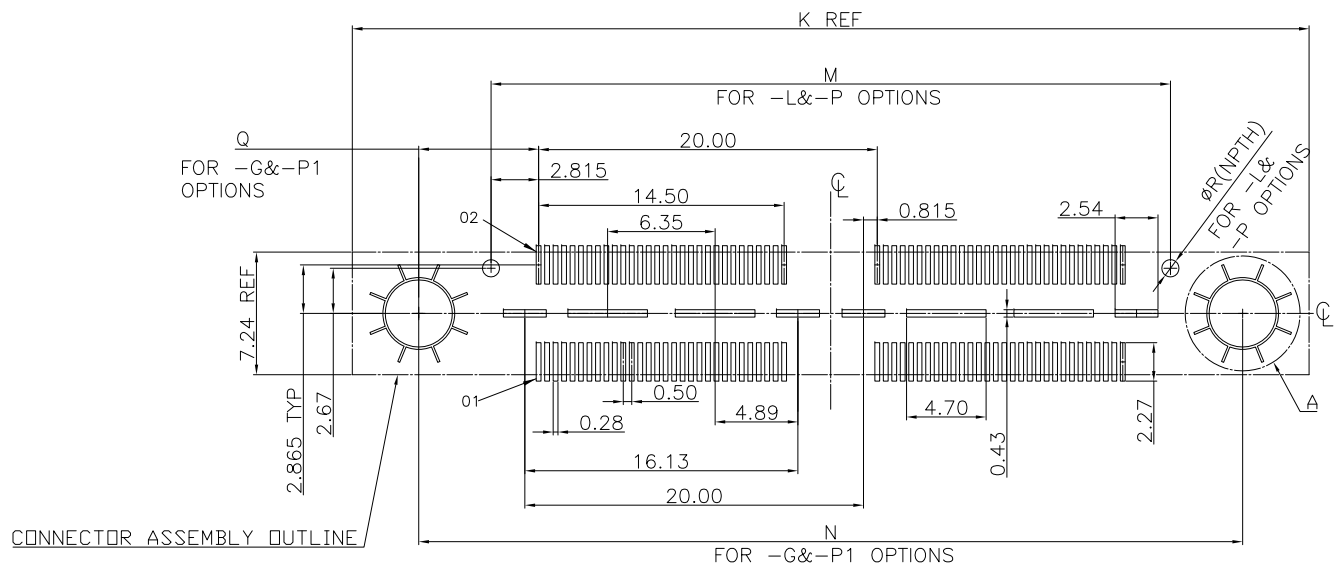

P.C.Board Layout
(Tolerance:±0.05)

OPTION	Q
-G	5.61
-P1	7.08

OPTION	R
-L	1.19
-P	1.02

POS	K			M		N	
	-L&P	-F	-G	-P1	-L&P	-G	-P1
60	21.31	20.38	30.89	36.53	20.13	25.73	28.68
120	41.31	40.39	50.89	56.53	40.13	45.73	48.68

Tolerances	Dwg. No.	2384-D0000-011	Title:	2384-A Series	
x = ±0.5	Projection		High Speed Board to Board	Pitch 0.5mm(Socket)	
.x = ±0.25	Unit	mm	Scale		1:1
.xx = ±0.15	Drawn By	WP 05/11'24			

2384-A Series
High Speed Board to Board
Pitch 0.5mm(Socket)

OUPIN
OUPIN ELECTRONIC(KUNSHAN) CO., LTD.
P/N: 2384-AxxFCxDP1Nxxx-x
SHEET 5/6 Ver. No. R4

REV.	SPECIFICATION	ECN NO.	APPD.
R4		ECN240516	

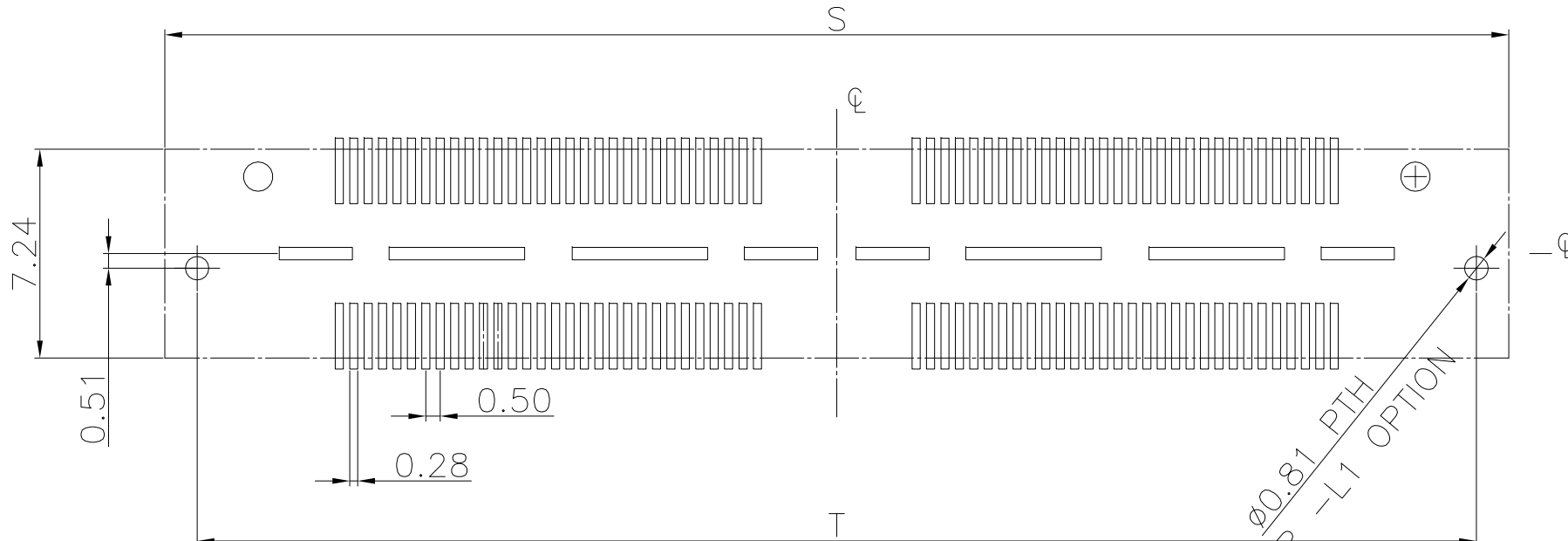

P.C.Board Layout
(Tolerance:±0.05)

TABLE 9		
POS	S	T
60	26.62	24.36
120	46.62	44.36

Tolerances	Dwg. No.	2384-D0000-011		Title:	
x = ±0.5	Projection			2384-A Series High Speed Board to Board Pitch 0.5mm(Socket)	
.x = ±0.25	Unit	mm	Scale		1:1
.xx = ±0.15	Drawn By	WP 05/11'24			

OUPIN			
OUPIN ELECTRONIC(KUNSHAN) CO., LTD.			
P/N:		2384-AxxFCxDP1Nxxx-x	
SHEET	6/6	Ver. No.	R4